

DOBRAR \ FOLD

MARCA DA DOBRA \ FOLD MARK

1 Faça as dobras indicadas no desenho, em um papel quadrado, para marcá-lo.

Make the folds indicated in the drawing, on one square paper, to mark it.

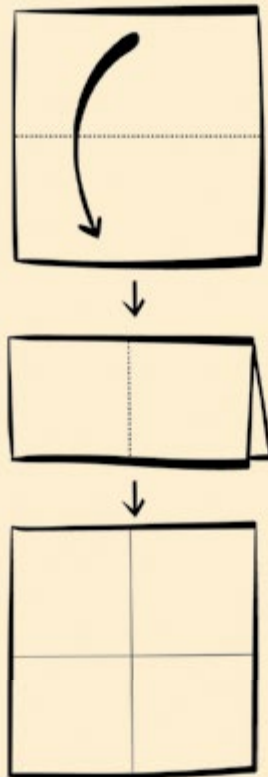

2 Leve as laterais do papel para o centro. Mantenha o papel dobrado para o próximo passo.

Take the sides of the paper to the center. Keep the paper folded for the next step.

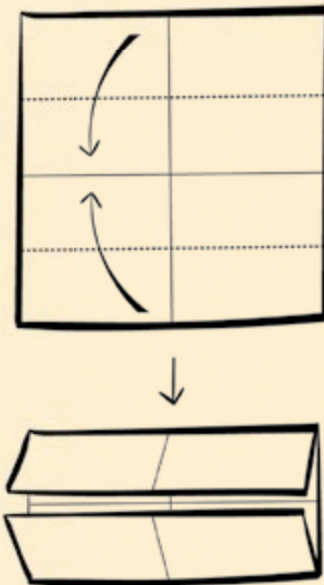

3 Leve as laterais do papel para o centro, como indicado no desenho. Depois, desfaça a dobra para o próximo passo.

Take the sides of the paper to the center as indicated in the drawing. Then undo the fold for the next step.

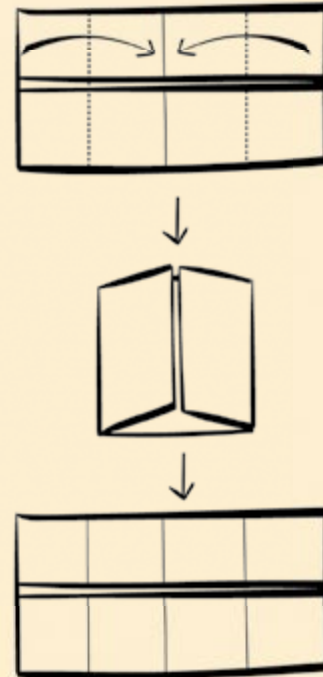

4 Leve as pontas do papel, como indicado no desenho, em direção ao centro. Pressione bem as dobras para marcar o papel.

Take the edge of the paper, as indicated in the drawing, towards the center. Press the folds down firmly to mark the paper.

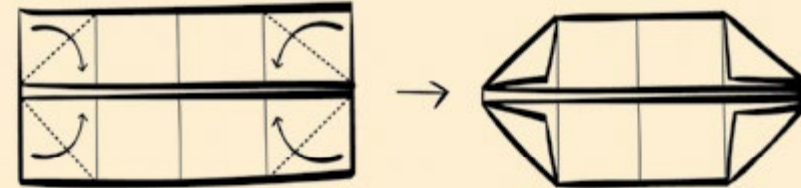

5 Desfaça as dobras e utilize a marcação da mesma para levar uma das pontas do papel até o centro, conforme o desenho.

Unfold it and use the same marking to take one of the edges of the paper to the center, as indicated below.

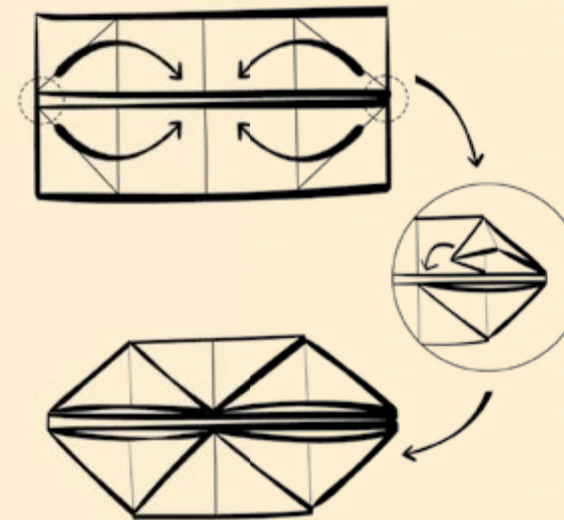

6 Dobre o papel ao meio, como indicado no desenho.

Fold the paper in half as indicated below.



7 Dobre o papel em direção ao centro do triângulo, como indicado no desenho, para fazer as perninhas da ariranha. (Faça esse processo nos dois lados da dobradura.)

Fold the paper towards the center of the triangle, as indicated in the drawing, to make the giant otter's legs. (Do this process on both sides of the fold.)

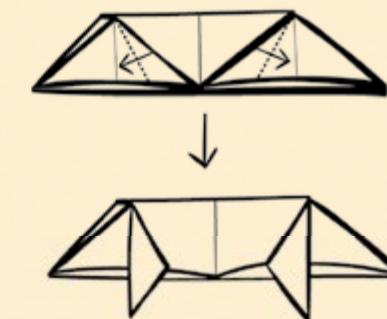

8 Abra a parte indicada no desenho e leve a ponta do papel até as costas da ariranha. Essa dobra fará o rostinho da ariranha.

Open the part indicated in the drawing and bring the end of the paper to the back of the giant otter. This fold will make the giant otter's face.

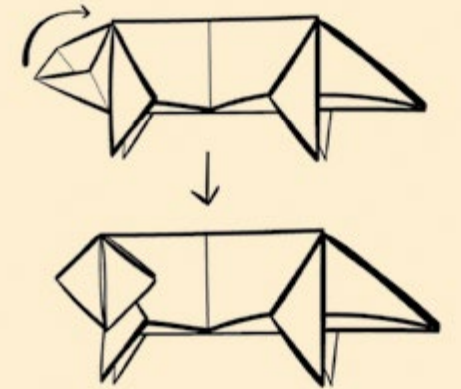

9 Dobre as laterais do papel, indicadas no desenho, para arredondar o formato do rostinho da ariranha. E com uma canetinha, desenhe olhos, nariz e boca.

Fold the sides of the paper, indicated in the drawing, to round the shape of the giant otter's face. And with a pen, draw eyes, nose and mouth.

